











	d_o [mm]	h_{nom} [mm]
 	10	[55 - 85]



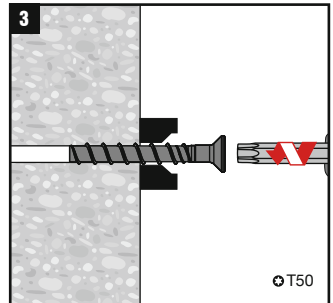
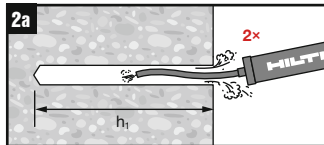
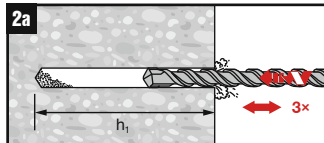
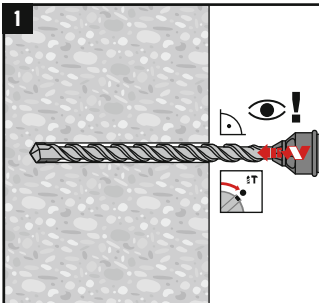

SIW 6AT-A22	
SIW 4AT-22	
SIW 6-22	
SIW 22T-A	
SIW 8-22	 
SIW 9-22	

	$h_1 = h_{nom} + 30 \text{ mm}$	2a
	$h_1 = h_{nom} + 10 \text{ mm}$	2b

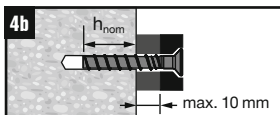
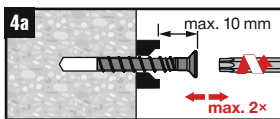

4 optional



	d_o [mm]	h_{nom} [mm]	
	10	< 75	
	10	≥ 75	